

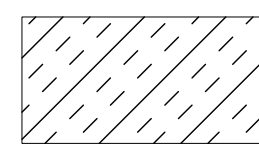

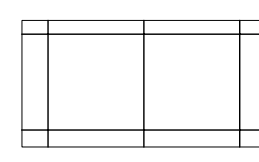
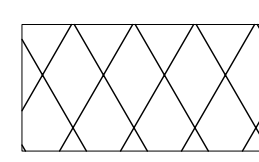
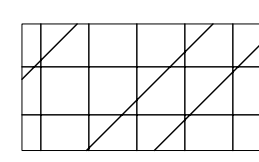
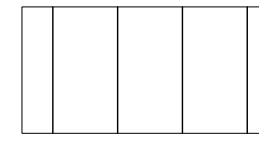

LEGEND:

CEILING TYPE

-  **GBA - GYPSUM BOARD CEILING ASSEMBLIES**
ABUSE AND MOLD RESISTANT WALL BOARD on SUSPENDED LT. GAGE METAL
-  **ACT - ACOUSTIC PANEL CEILING**
NRC GREATER THEN 0.70
-  **SCA - SECURITY CEILING ASSEMBLIES**
ABUSE RESISTANT WALL BOARD over SECURE STEEL MESH
-  **SCA/AT - SECURITY CEILING ASSEMBLIES w/ GLUED ACOUSTICAL TILE**
AT-1 on GYPSUM BOARD over SECURE MESH
-  **SSC - SECURITY PLANK STEEL CEILINGS**
-  **PAINTED FINISH**
-  **EP - EPOXY PAINT ON CONCRETE CEILING**
- LIGHT FIXTURES**
-  **SURFACE MOUNTED**
-  **CORNER MOUNTED**
-  **RECESSED**
-  **RECESSED**
-  **PENDANT**
-  **WALL MOUNTED**
- MECHANICAL FIXTURES**
-  **DIFFUSERS**
-  **EXHAUST**

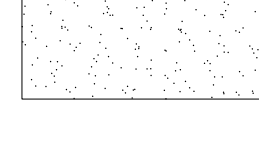
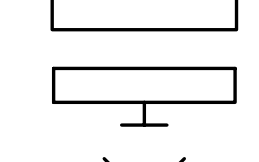
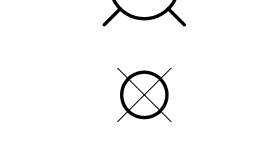
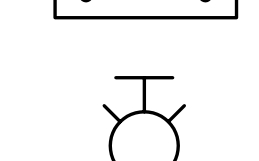
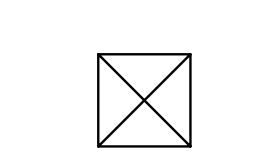
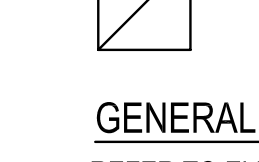
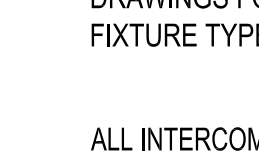
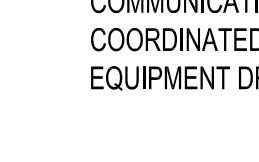
GENERAL NOTE:
REFER TO ELECTRICAL AND MECHANICAL DRAWINGS FOR LIGHT FIXTURE AND MECHANICAL FIXTURE TYPES.

ALL INTERCOM, EMERGENCY CALL BUTTON, CARD READER/FOB, AND COMMUNICATION DEVICES TO BE COORDINATED WITH SECURITY EQUIPMENT DRAWINGS

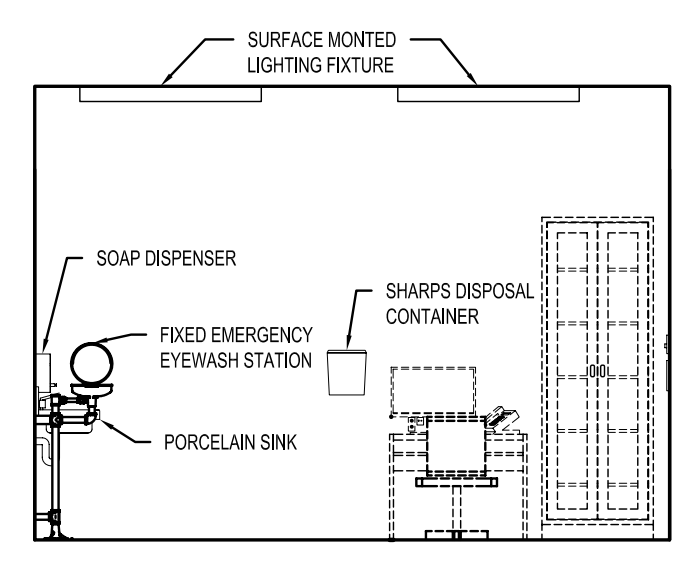

4E ELEVATION
1:50

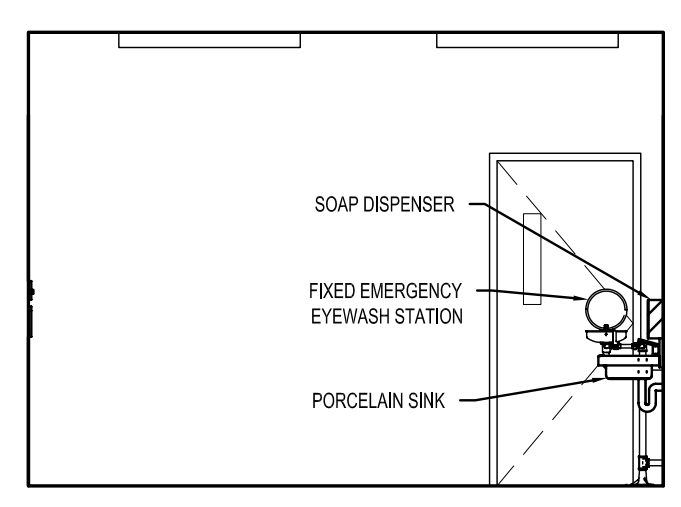

4D ELEVATION
1:50

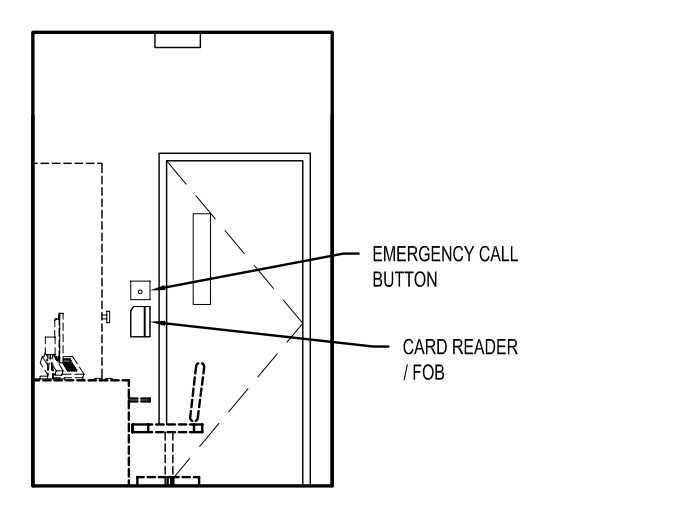

4C ELEVATION
1:50

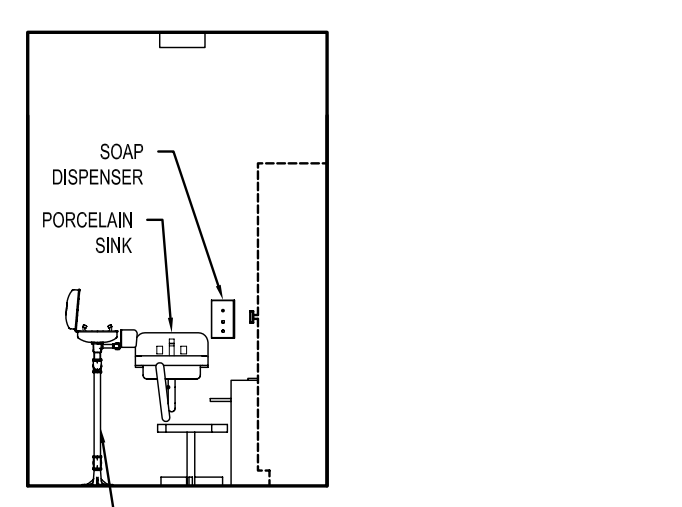

4B ELEVATION
1:50

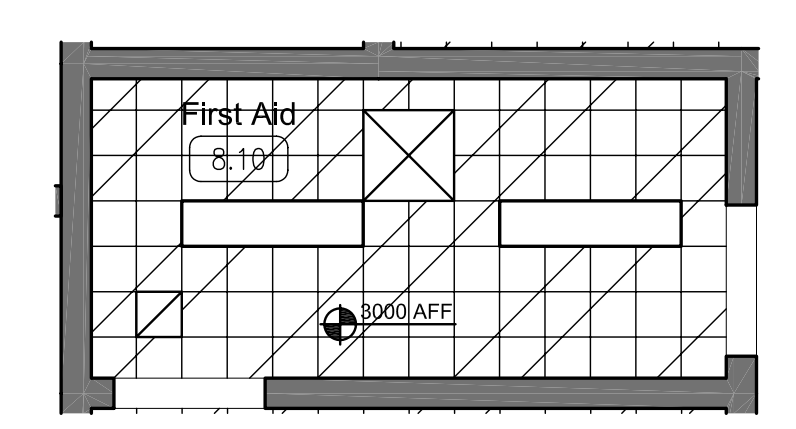

4A REFLECTED CEILING PLAN
1:50

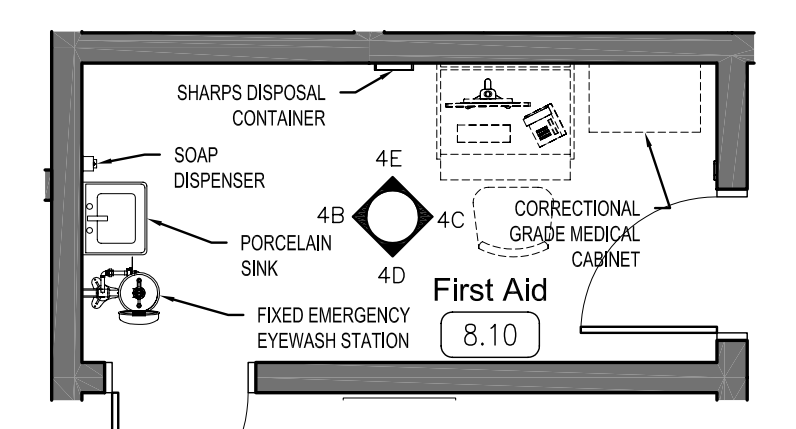

4 HCU FIRST AID ROOM - ENLARGED PLAN
1:50

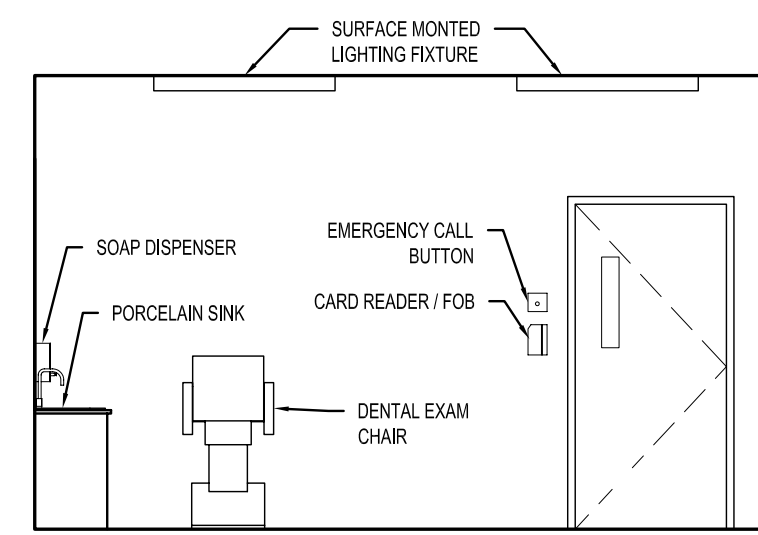

3E ELEVATION
1:50

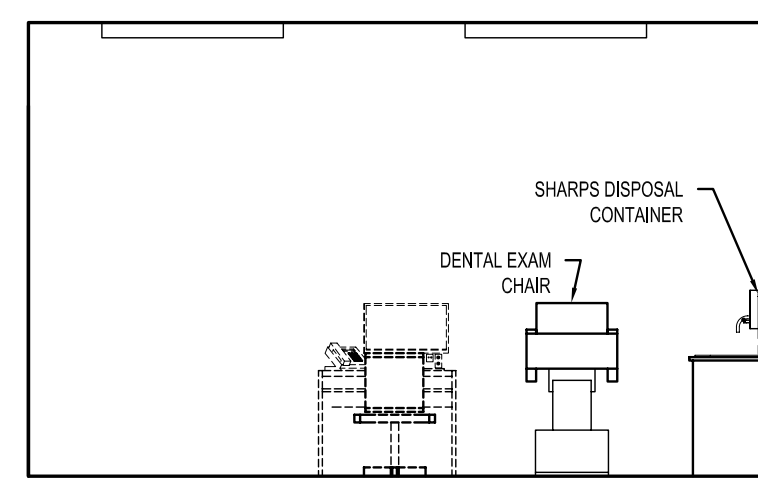

3D ELEVATION
1:50

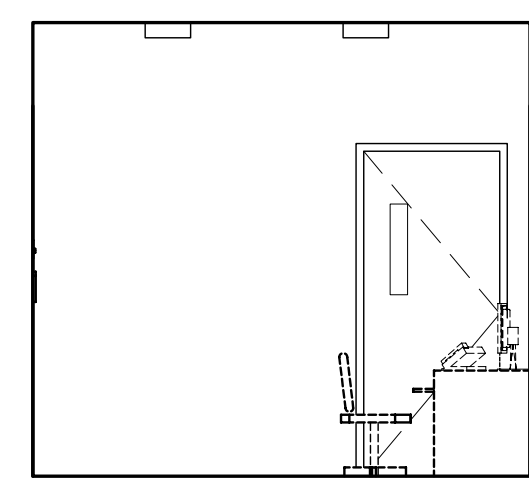

3C ELEVATION
1:50

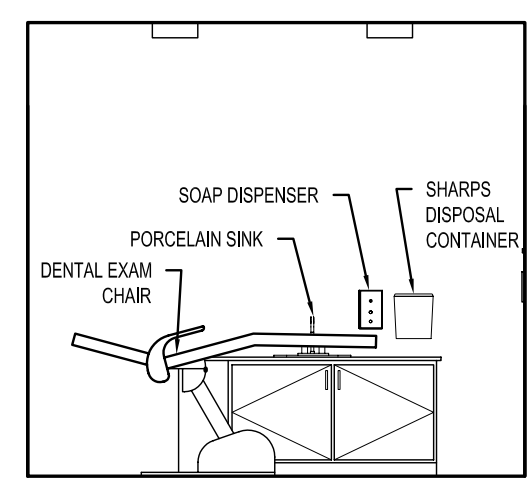

3B ELEVATION
1:50

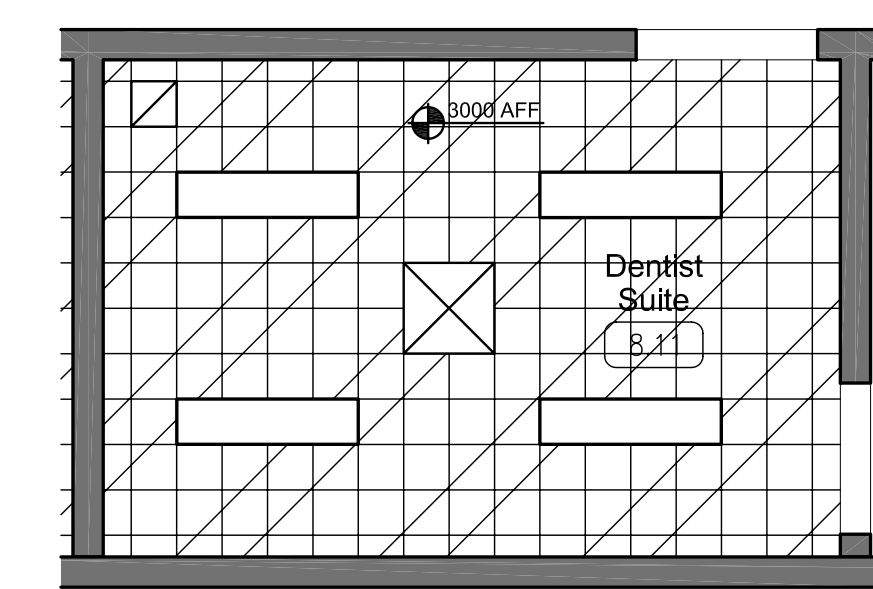

3A REFLECTED CEILING PLAN
1:50

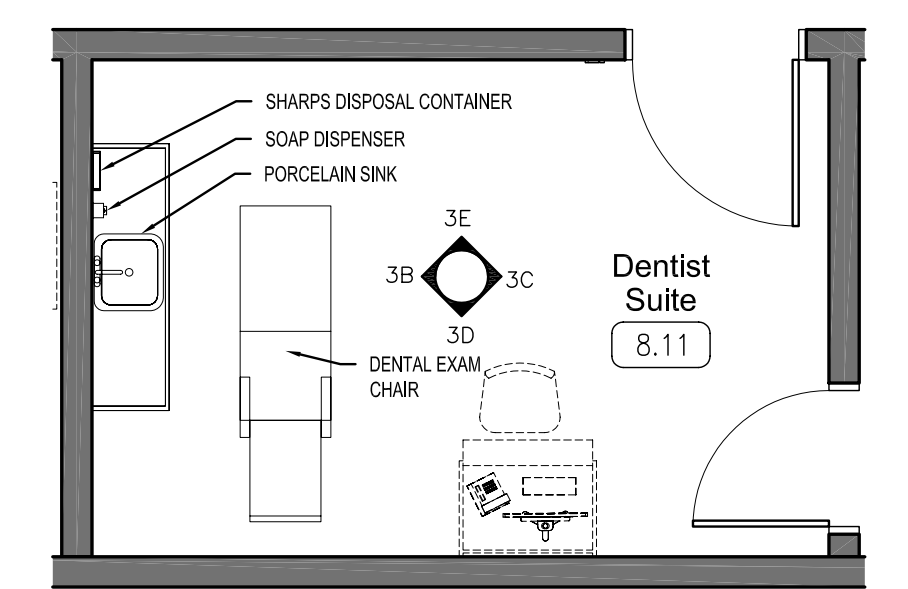

3 DENTIST SUITE - ENLARGED PLAN
1:50

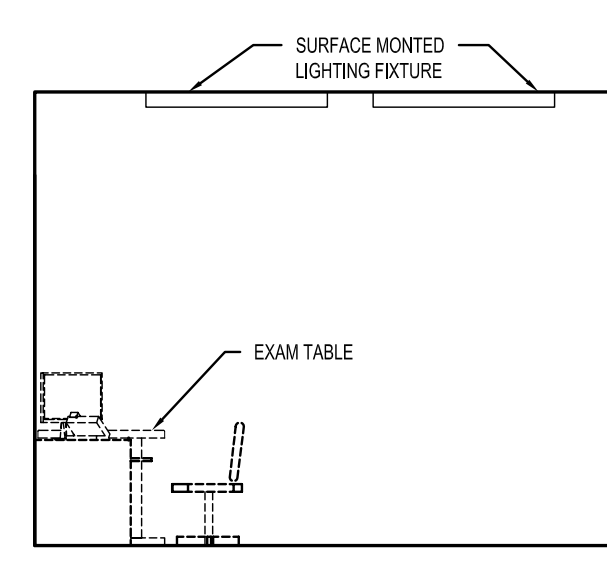

2E ELEVATION
1:50

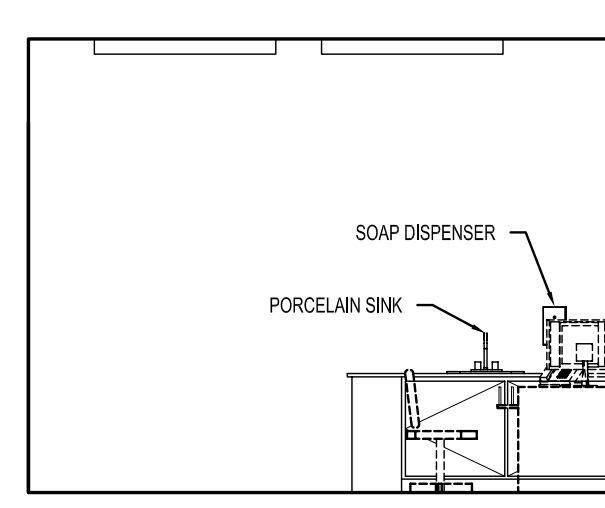

2D ELEVATION
1:50

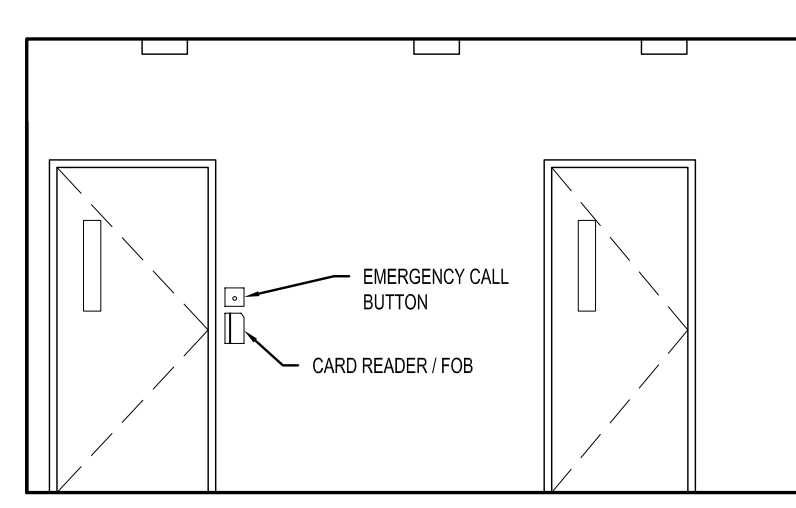

2C ELEVATION
1:50

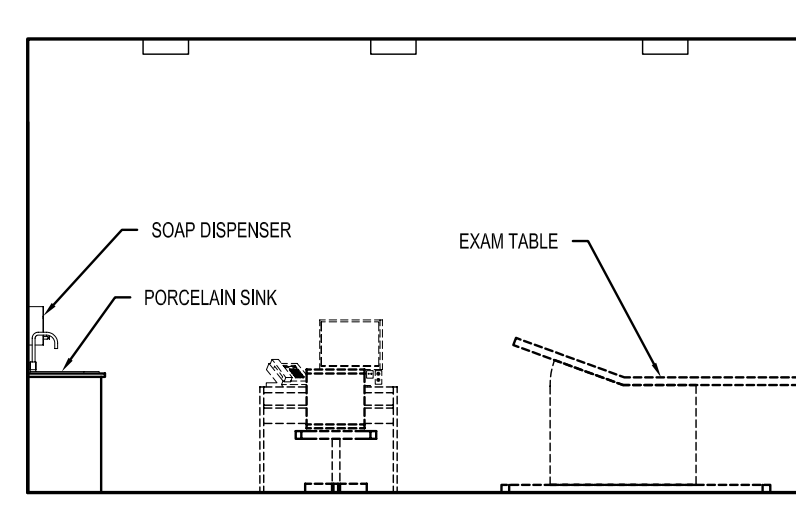

2B ELEVATION
1:50

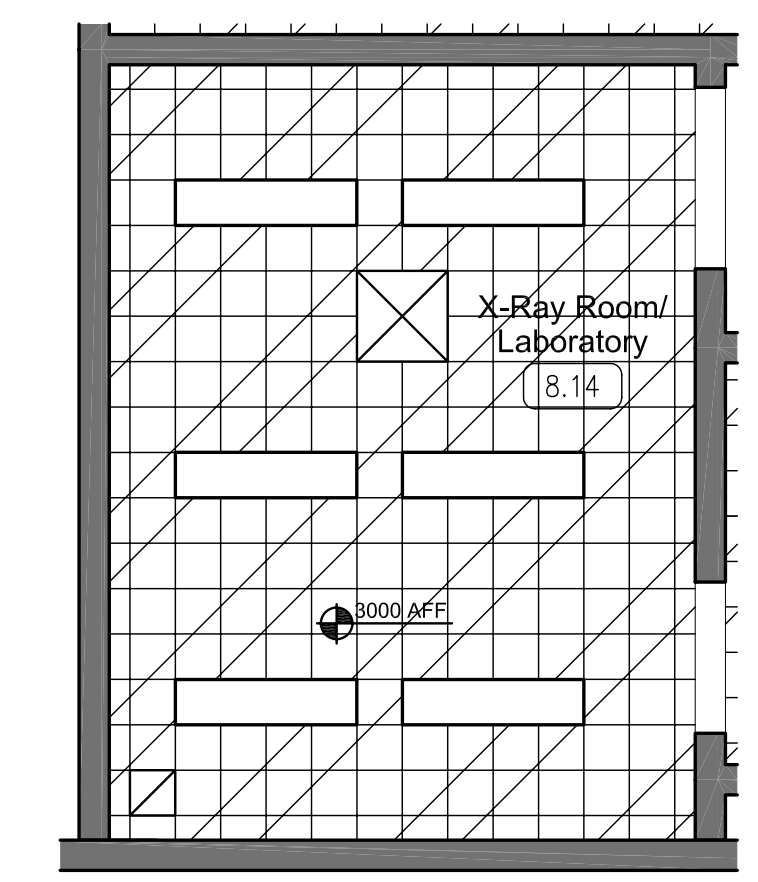

2A REFLECTED CEILING PLAN
1:50

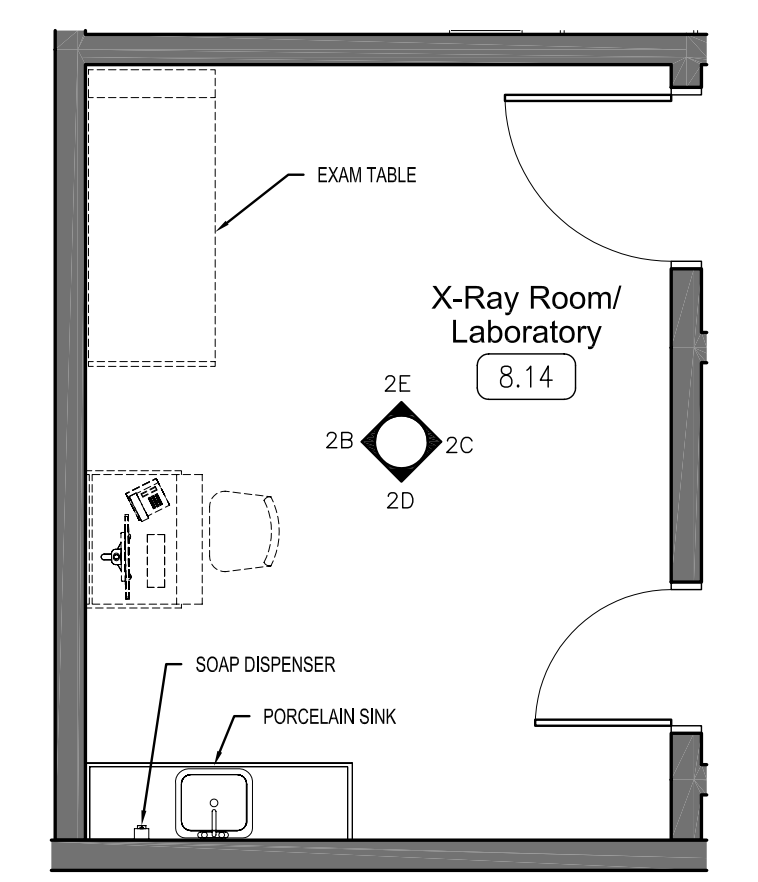

2 X-RAY ROOM - ENLARGED PLAN
1:50

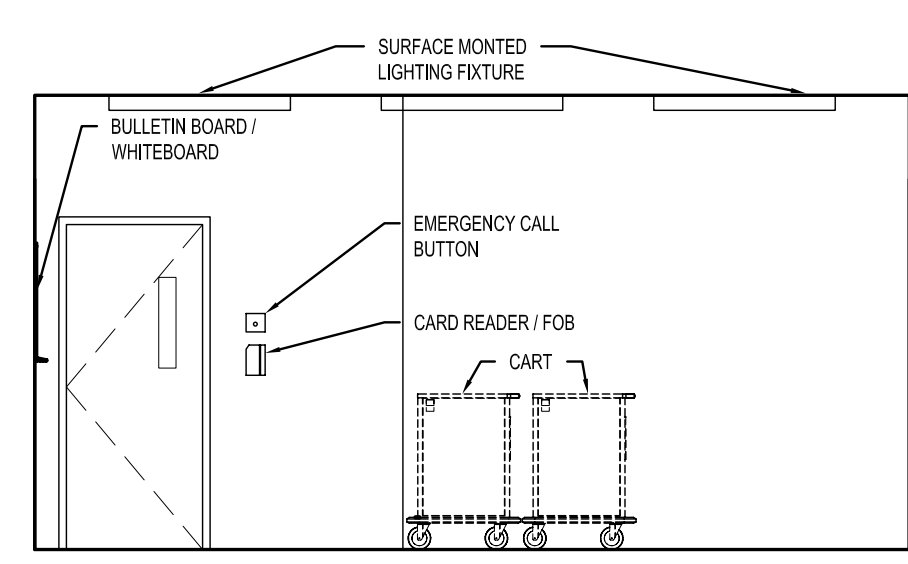

1E ELEVATION
1:50

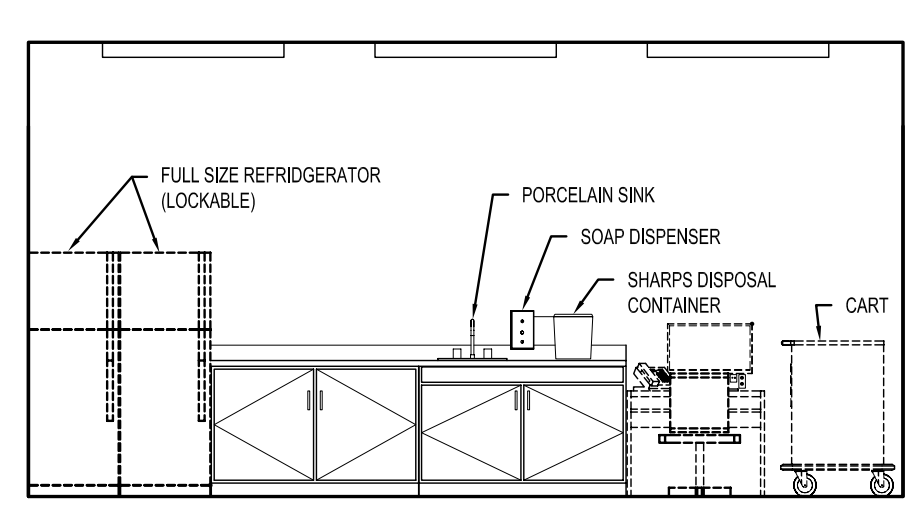

1D ELEVATION
1:50

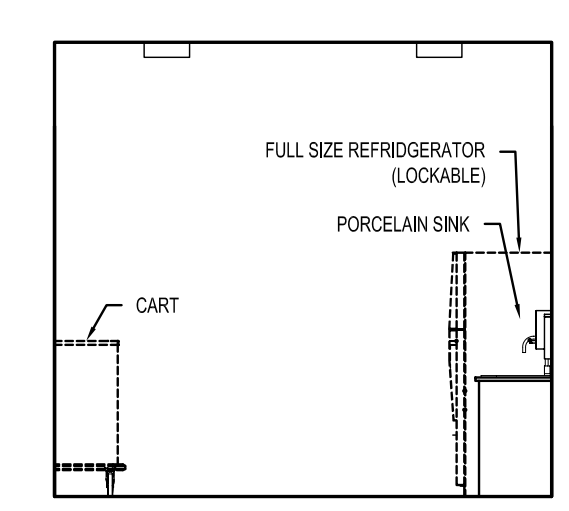

1C ELEVATION
1:50

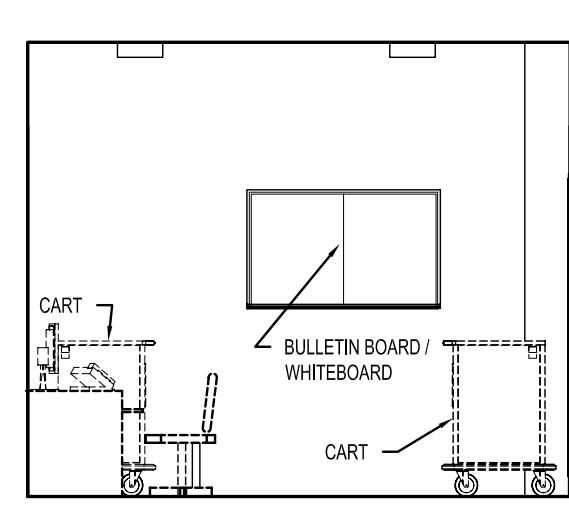

1B ELEVATION
1:50

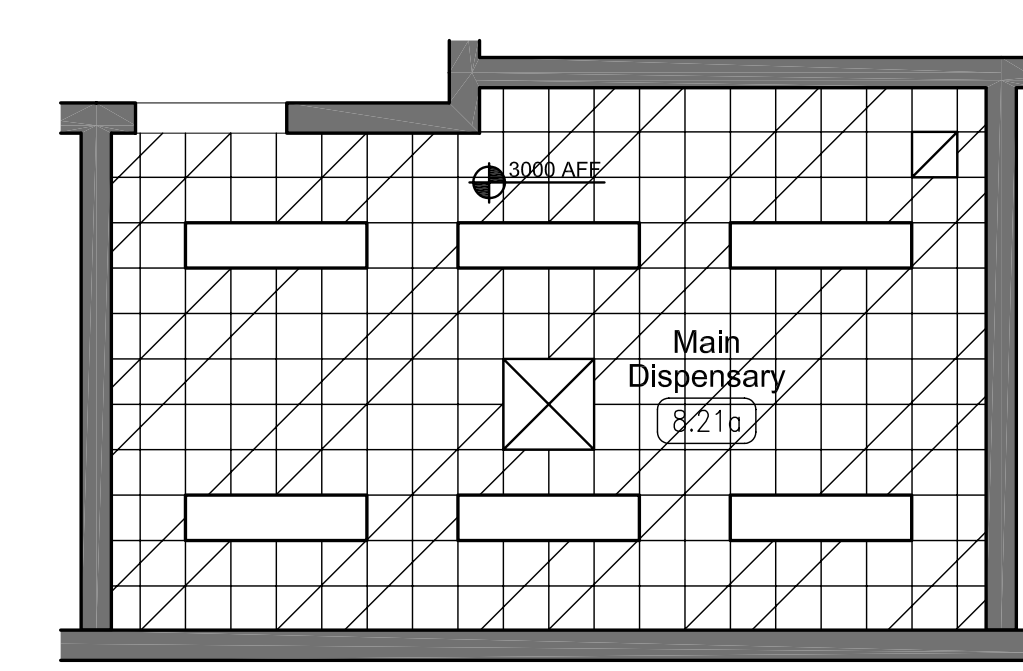

1A REFLECTED CEILING PLAN
1:50

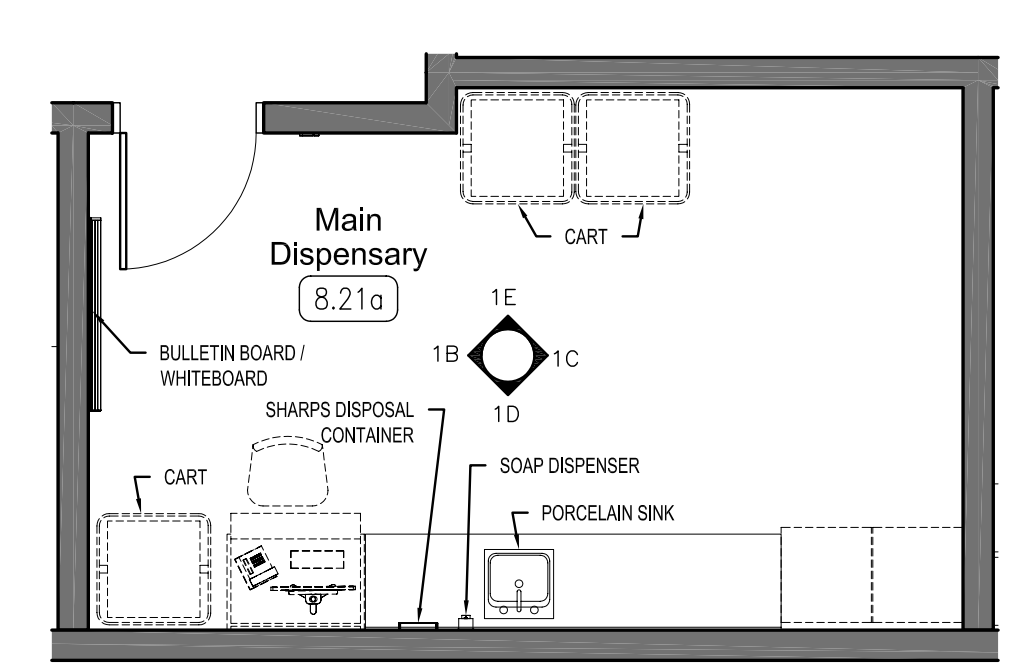

1 HCU MAIN DISPENSARY - ENLARGED PLAN
1:50

all designs, drawings, and related documents prepared by the architect are instruments of service for the execution of the work and are the property of Plenary Justice. They are not to be used for any other project without the written permission of the architect.

