

LEGEND:

CEILING TYPE

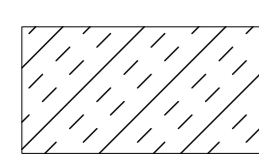

GBA - GYPSUM BOARD CEILING ASSEMBLIES
ABUSE AND MOLD RESISTANT WALL BOARD ON SUSPENDED LT. GAGE METAL

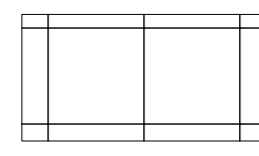

ACT - ACOUSTIC PANEL CEILING
NRC GREATER THEN 0.70

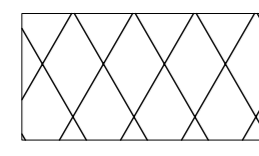

SCA - SECURITY CEILING ASSEMBLIES
ABUSE RESISTANT WALL BOARD OVER SECURE STEEL MESH

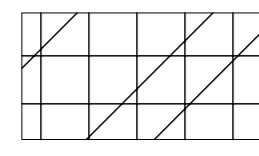

SCA/AT - SECURITY CEILING ASSEMBLIES w/ GLUED ACOUSTICAL TILE
AT-1 on GYPSUM BOARD over SECURE MESH

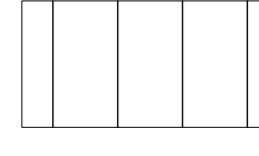

SSC - SECURITY PLANK STEEL CEILINGS



PAINTED FINISH

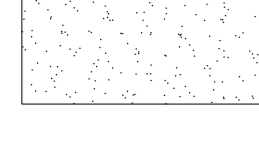

EP - EPOXY PAINT ON CONCRETE CEILING

LIGHT FIXTURES

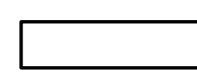

SURFACE MOUNTED

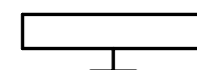

CORNER MOUNTED



RECESSED



RECESSED



PENDANT

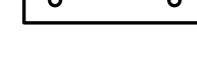

WALL MOUNTED



MECHANICAL FIXTURES



DIFFUSERS



EXHAUST

GENERAL NOTE:

REFER TO ELECTRICAL AND MECHANICAL DRAWINGS FOR LIGHT FIXTURE AND MECHANICAL FIXTURE TYPES.

ALL INTERCOM, EMERGENCY CALL BUTTON, CARD READER/FOB, AND COMMUNICATION DEVICES TO BE COORDINATED WITH SECURITY EQUIPMENT DRAWINGS

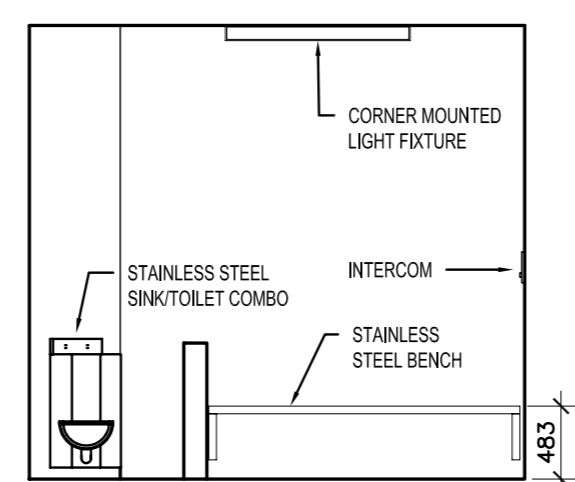

5D ELEVATION
1:50

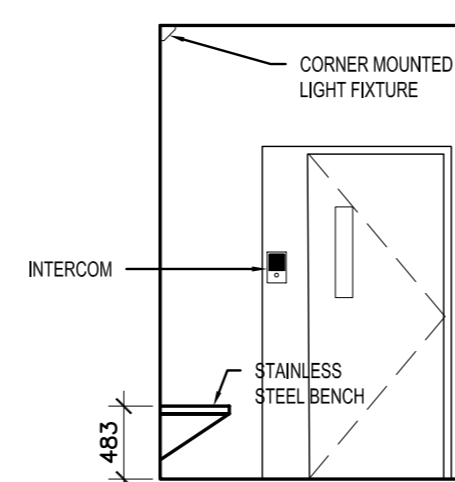

5C ELEVATION
1:50

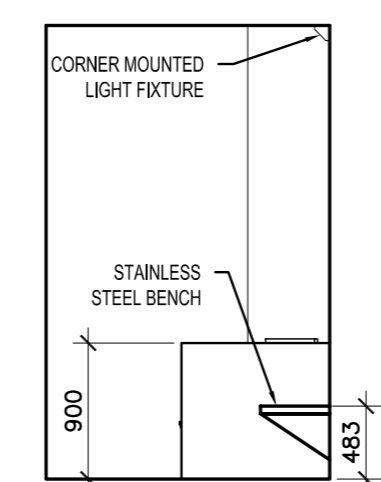

5B ELEVATION
1:50

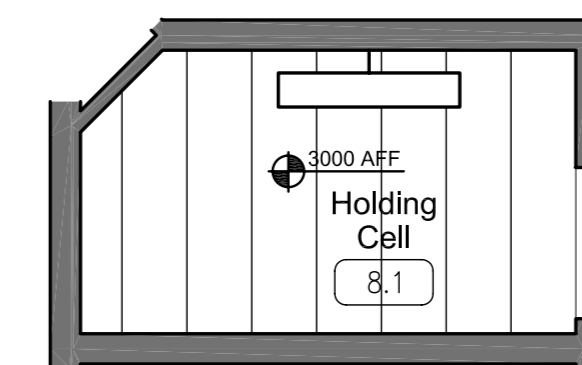

5A REFLECTED CEILING PLAN
1:50

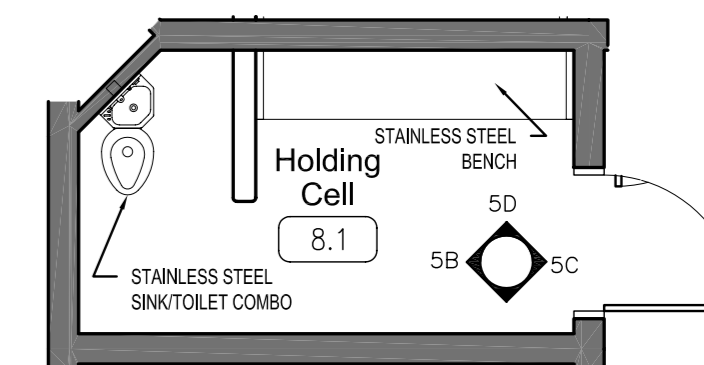

5 HCU HOLDING CELL - ENLARGED PLANS
1:50

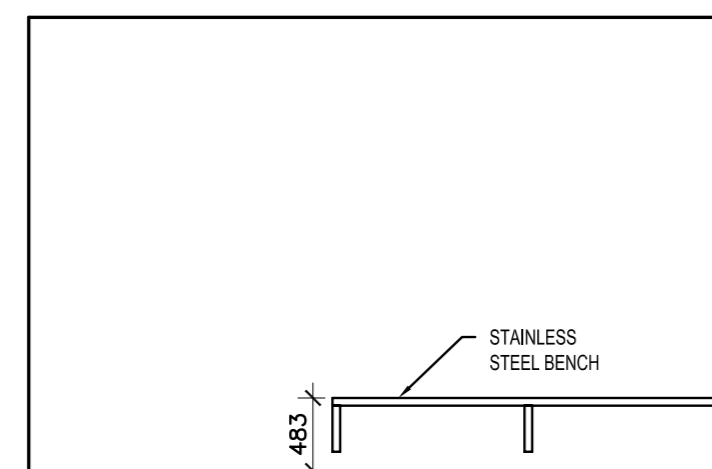

4E ELEVATION
1:50

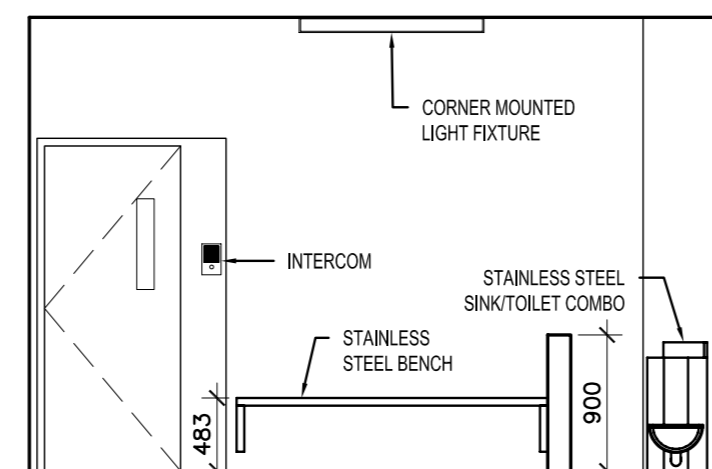

4D ELEVATION
1:50

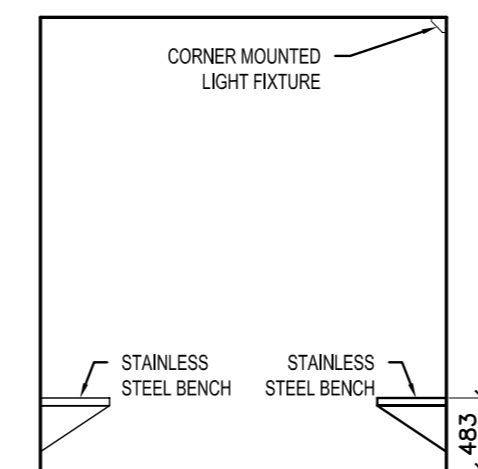

4C ELEVATION
1:50

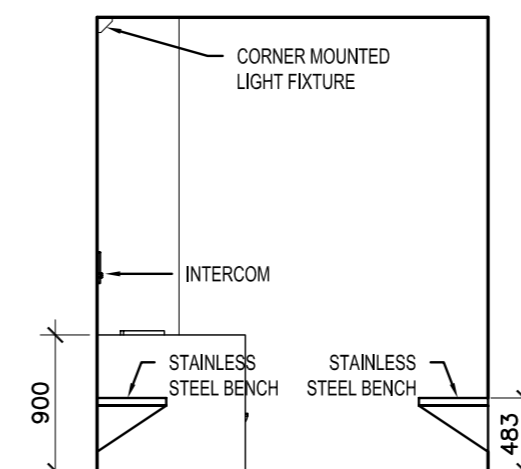

4B ELEVATION
1:50

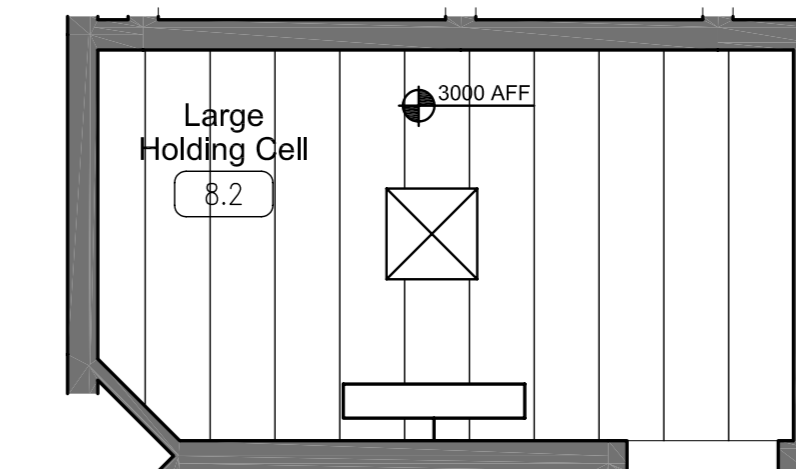

4A REFLECTED CEILING PLAN
1:50

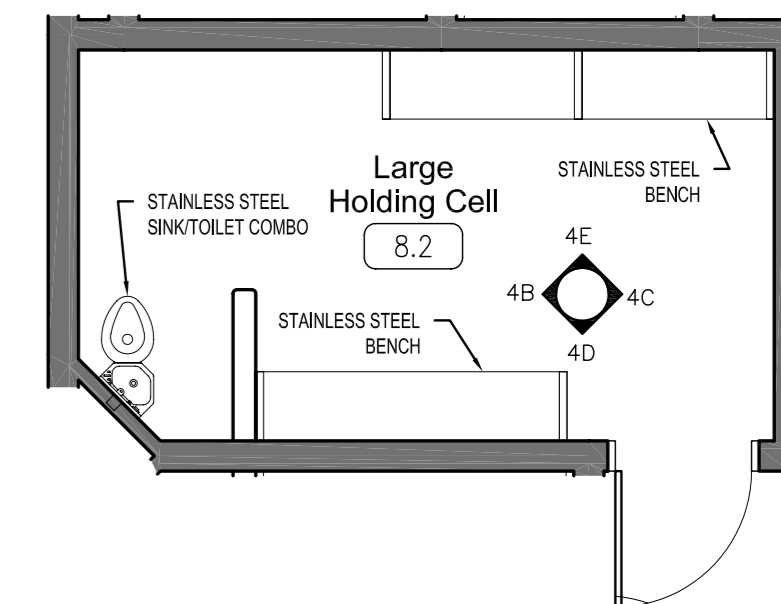

4 HCU LARGE HOLDING CELL - ENLARGED PLANS
1:50

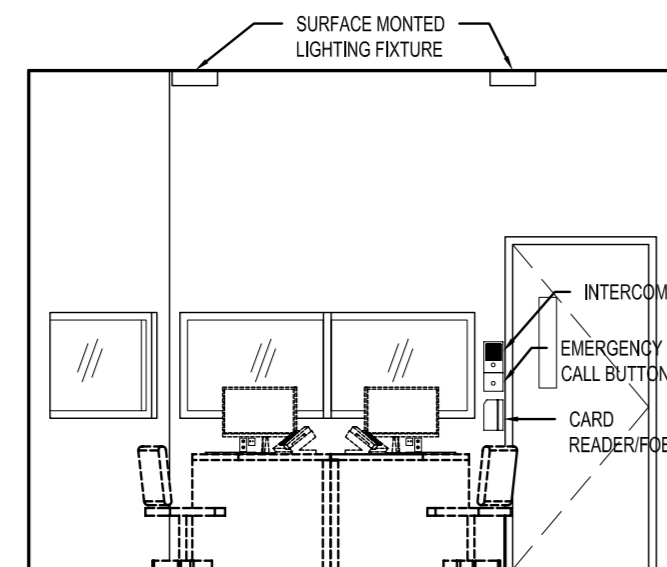

3E ELEVATION
1:50

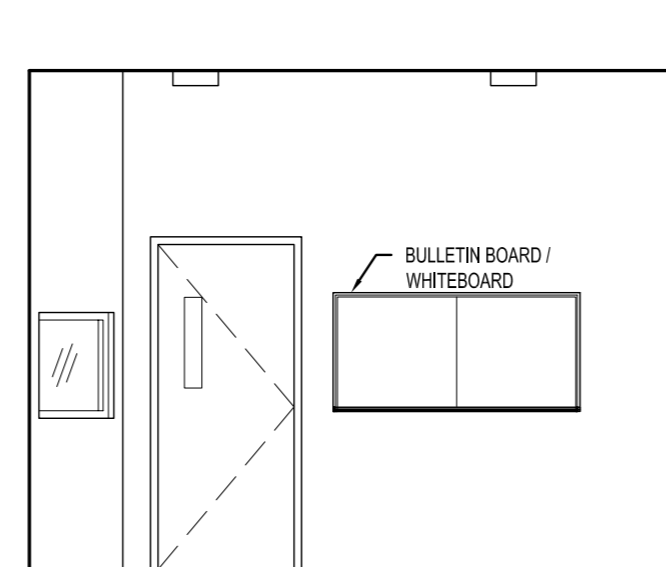

3D ELEVATION
1:50

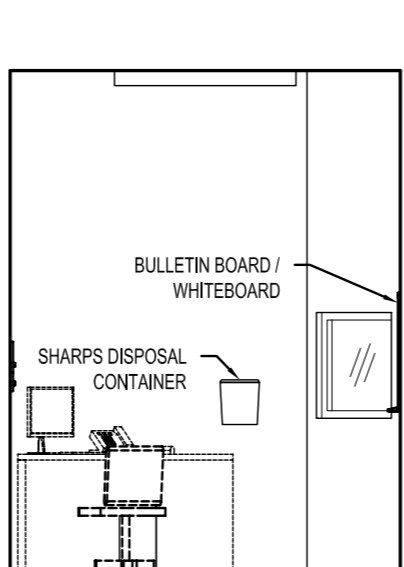

3C ELEVATION
1:50

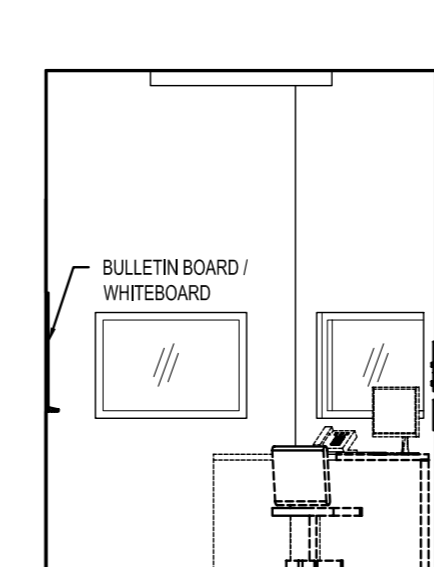

3B ELEVATION
1:50

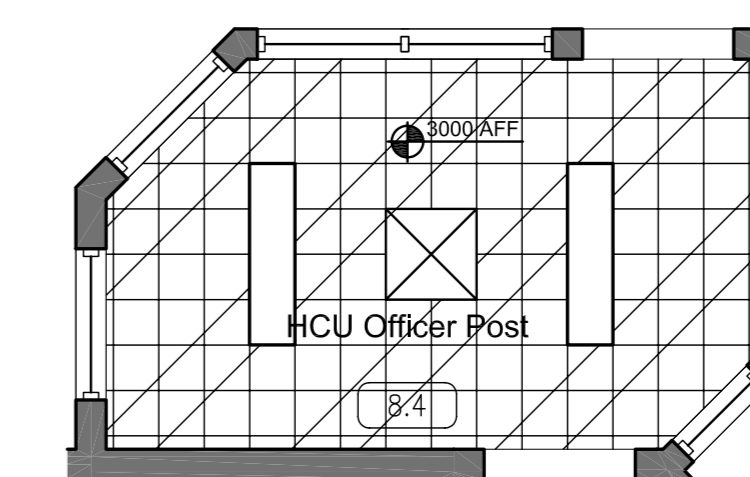

3A REFLECTED CEILING PLAN
1:50

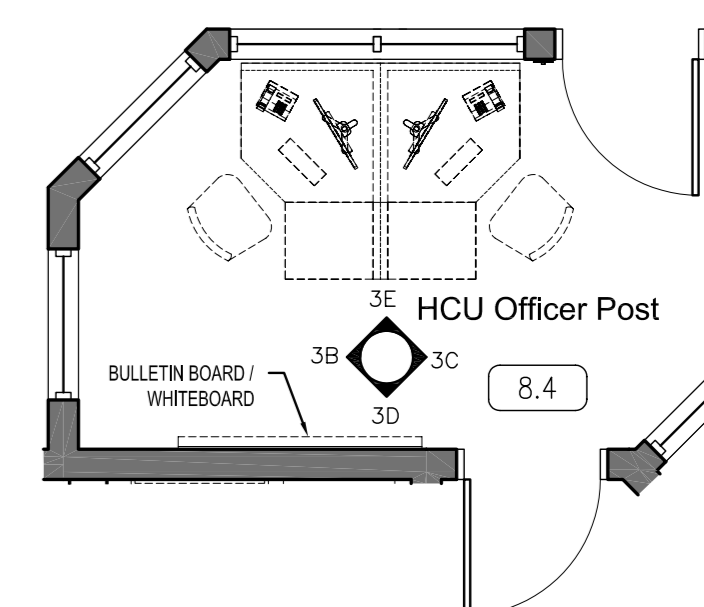

3 HCU OFFICER POST - ENLARGED PLANS
1:50

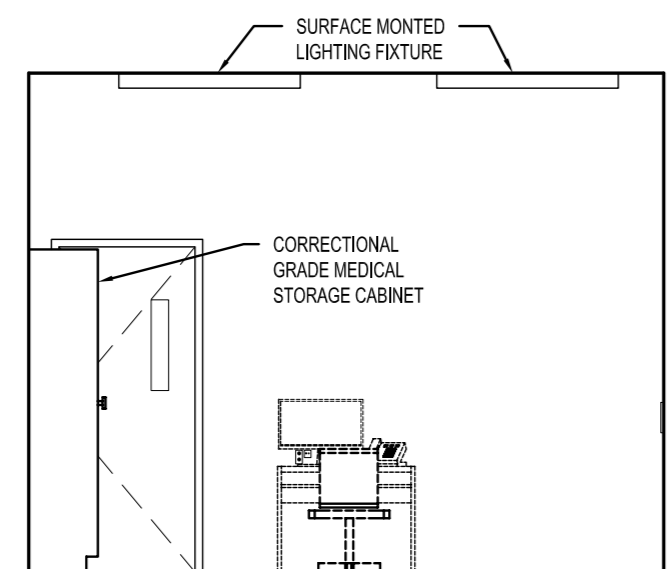

2E ELEVATION
1:50

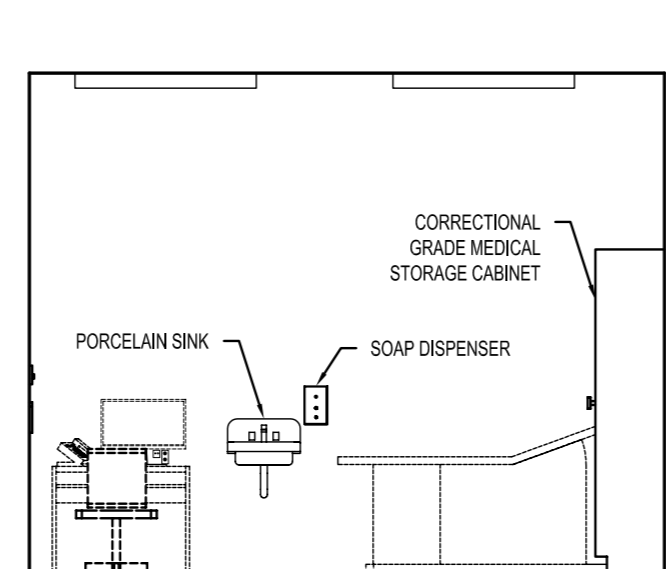

2D ELEVATION
1:50

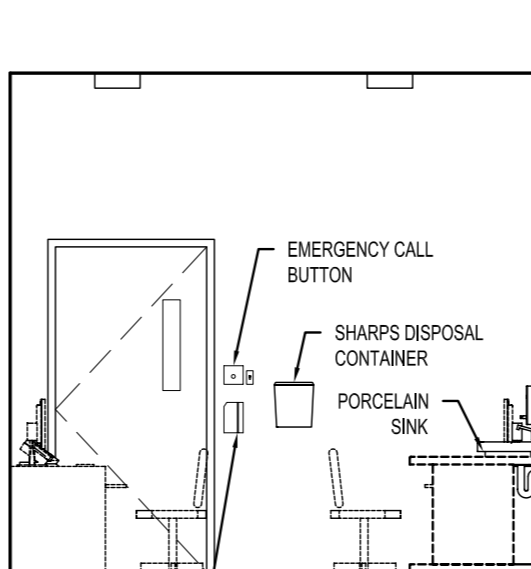

2C ELEVATION
1:50

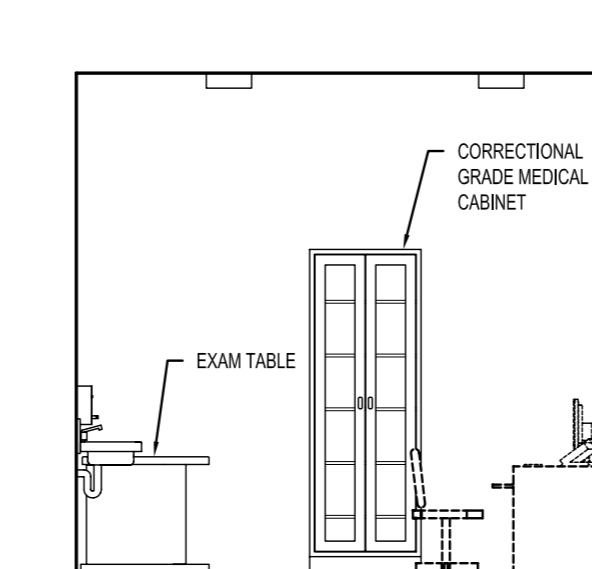

2B ELEVATION
1:50

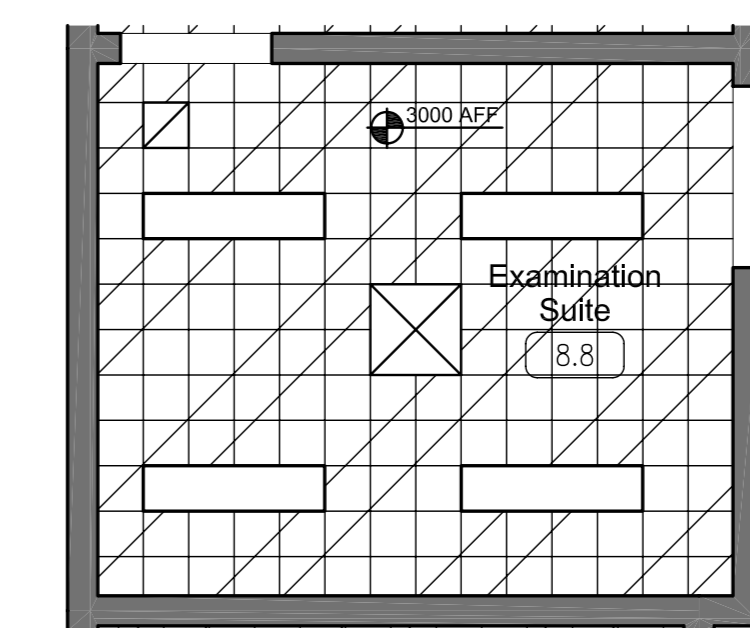

2A REFLECTED CEILING PLAN
1:50

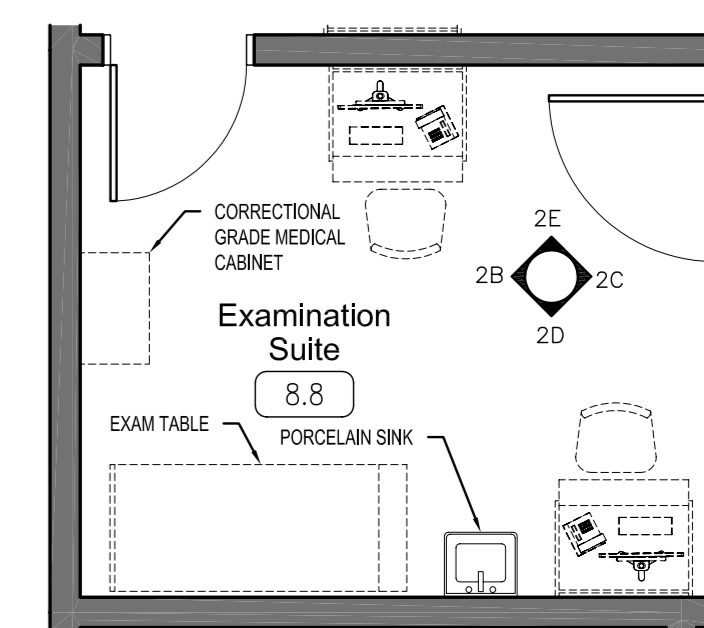

2 HCU EXAMINATION SUITE - ENLARGED PLANS
1:50

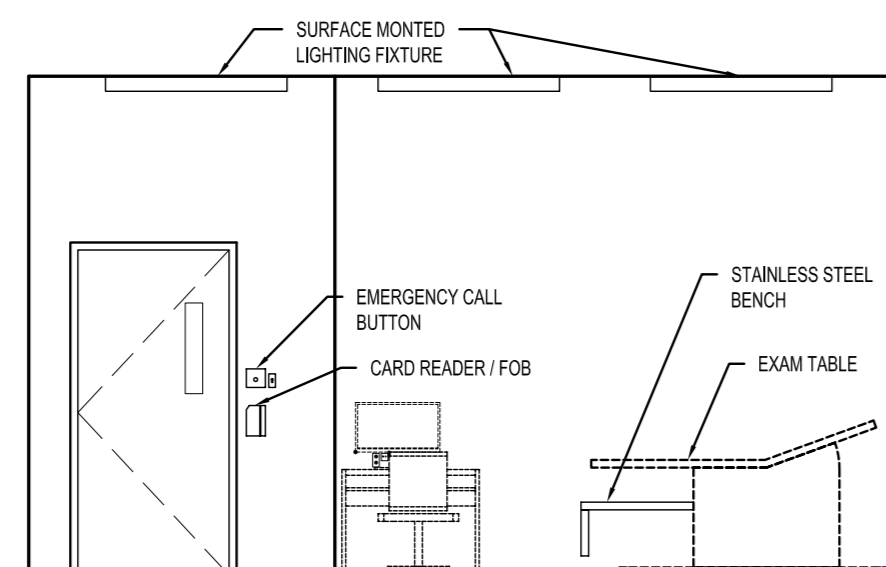

1E ELEVATION
1:50

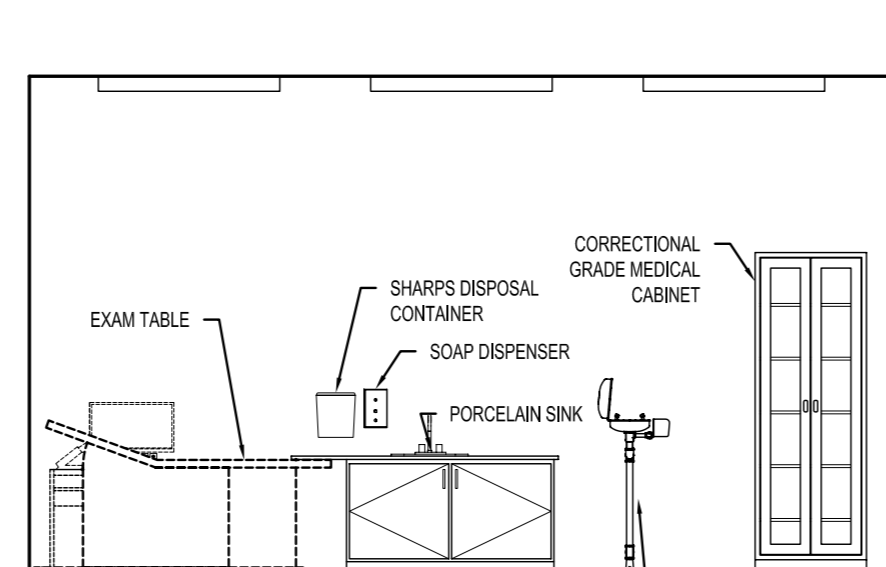

1D ELEVATION
1:50

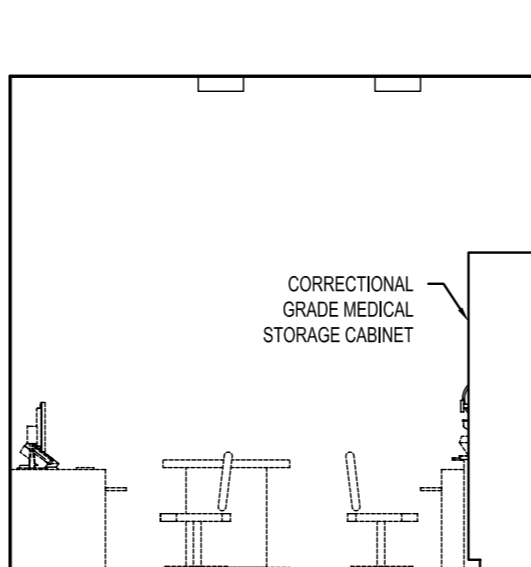

1C ELEVATION
1:50

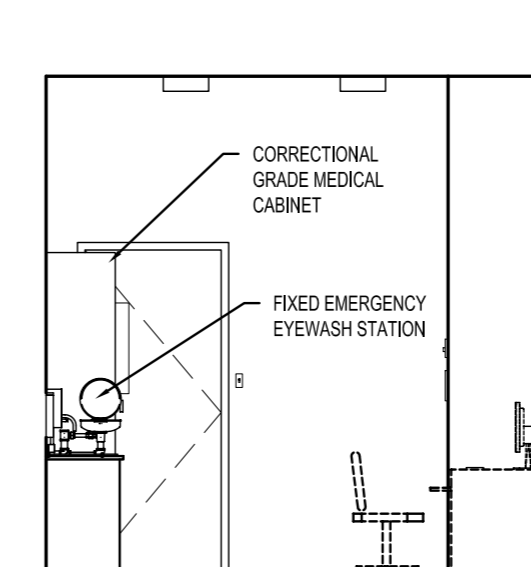

1B ELEVATION
1:50

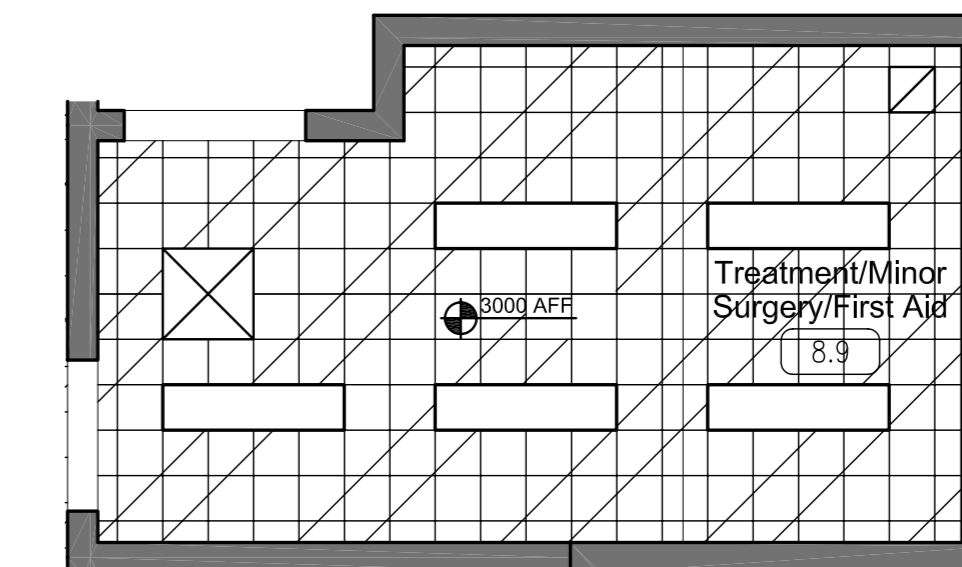

1A REFLECTED CEILING PLAN
1:50

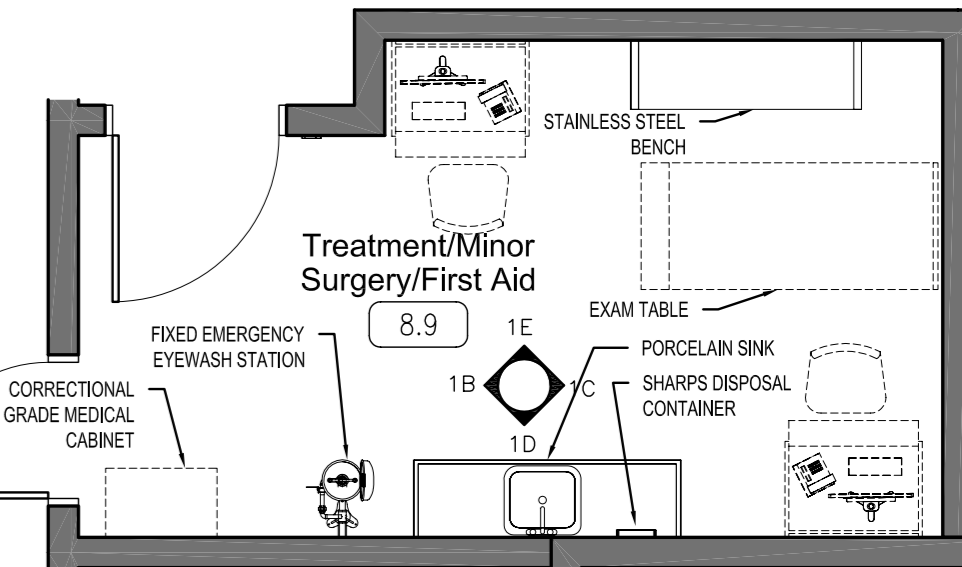

1 TREATMENT/MINOR SURGERY/FIRST AID ENLARGED PLANS
1:50

all designs, drawings, and related documents prepared by the architect are instruments of service for the execution of the work and are property of Plenary Justice. They are not to be used for any other project without the written permission of the architect.